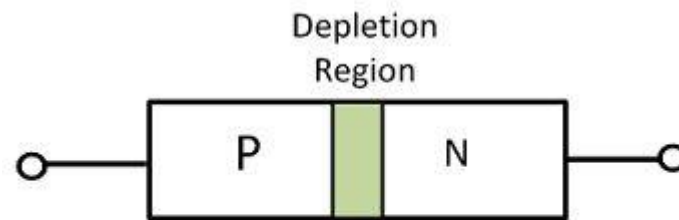
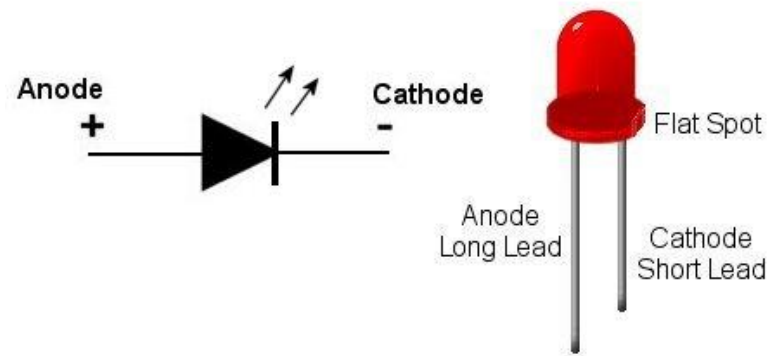

PWM 신호를 이용한 LED 밝기 제어

LED

PWM

BJT

LED(Light Emitting Diode)



PN Junction Diode Circuit Globe

V-I Characteristic

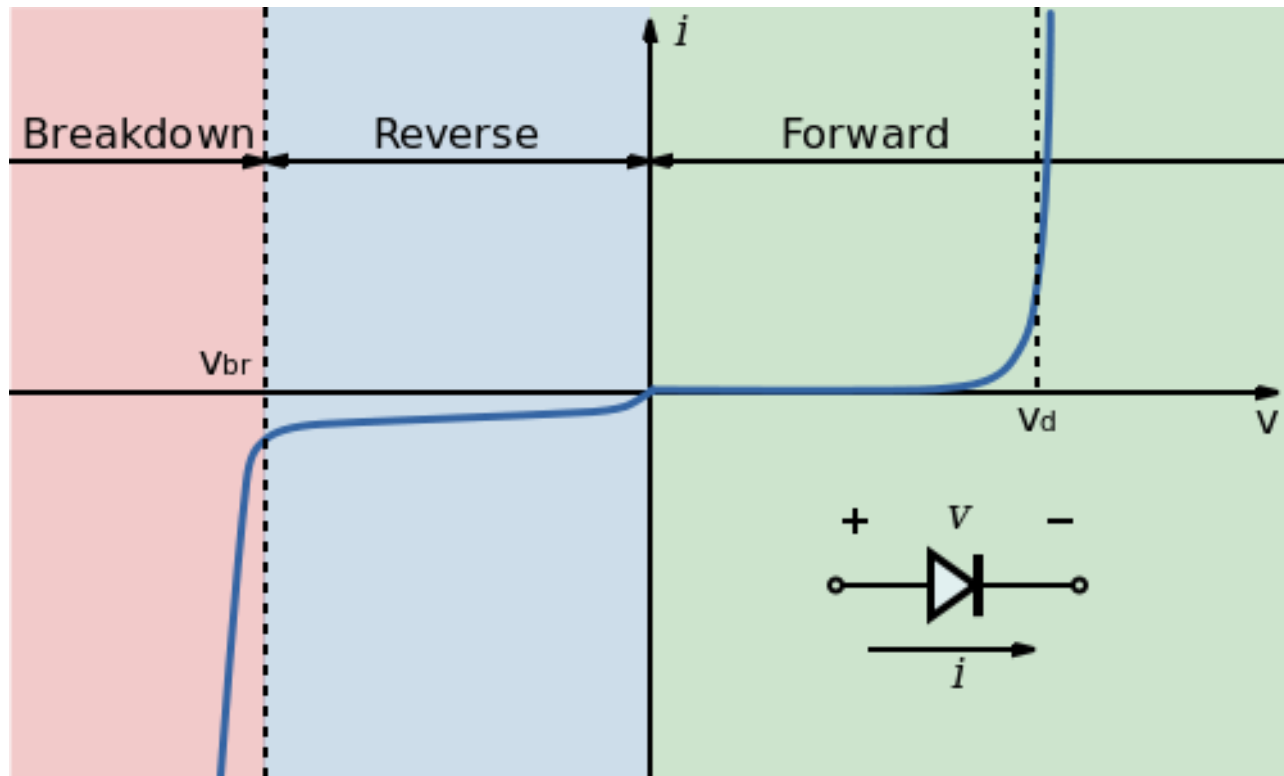

PWM(Pulse Width Modulation)

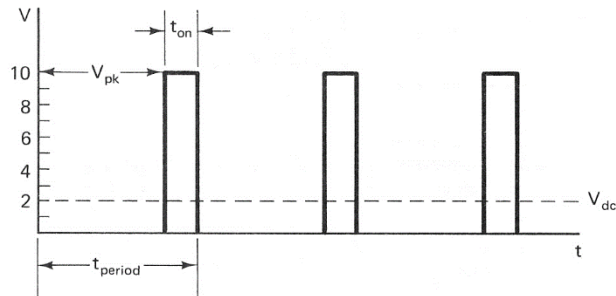

(a)

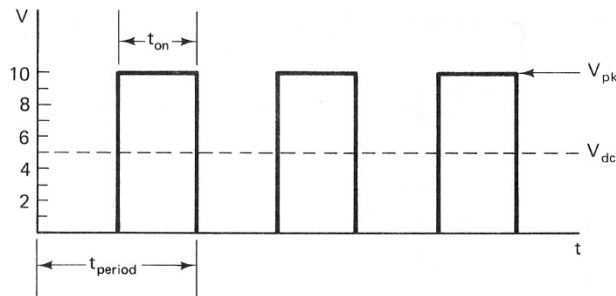

(b)

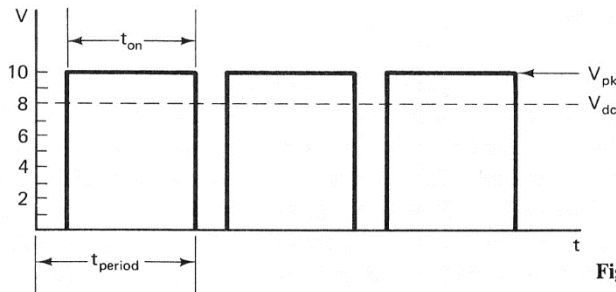

(c)

$$\text{duty cycle} = \frac{t_{on}}{t_{period}} \times 100\%$$

Fig
narr
(c) 1

PWM Circuit

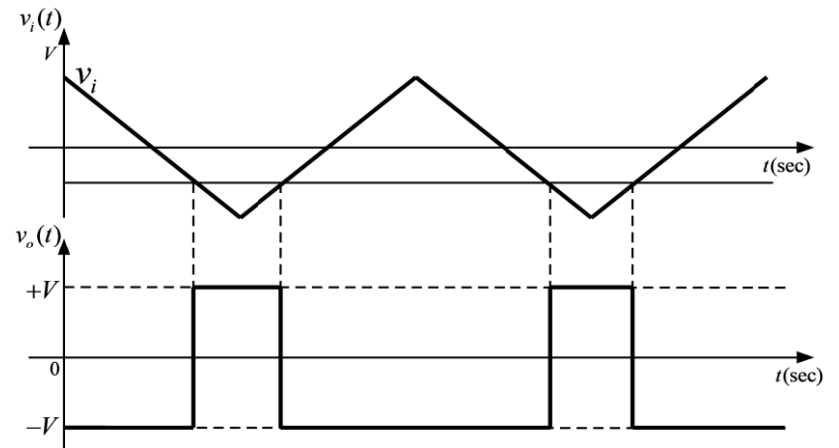
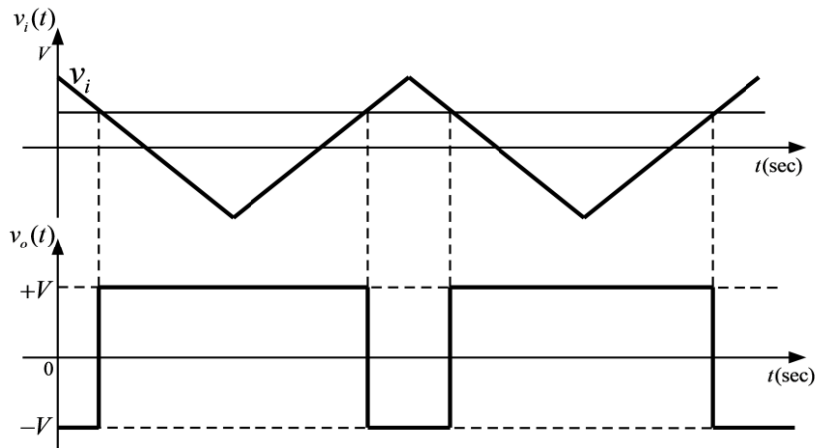
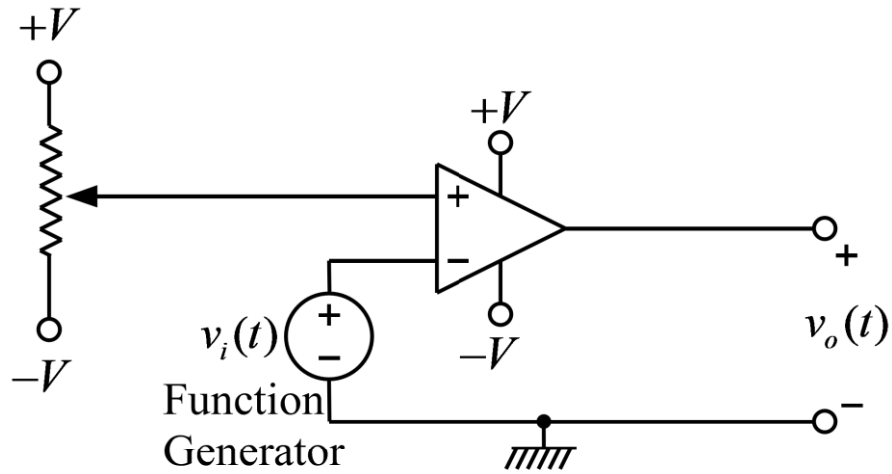

BJT(Bipolar Junction Transistor)

